



Cert. No. LRQ 0963008

ISO 9001

spirax sarco

TI-S01-03
ST Issue 9

TD42L and TD42H Thermodynamic Steam Traps

Description

The TD42L and TD42H are maintainable thermodynamic steam traps. The TD42L is specifically designed for relatively small condensate loads and therefore is ideal for mains drainage applications. For process type loads the TD42H is available. For those applications where the release of air is a concern, an anti-air-binding disc is available i.e. TD42LA and TD42HA. All external body surfaces have an electroless nickel preparation (ENP) which is both energy saving and oxidation resistant.

Standards

These products fully comply with the requirements of the European Pressure Equipment Directive 97/23/EC.

Certification

This product is available with a manufactures' Typical Test Report. **Note:** All certification/inspection requirements must be stated at time of order placement.

Sizes and pipe connections

TD42L	3/8", 1/2", 3/4" and 1"	screwed BSP or NPT
TD42H	1/2", 3/4" and 1"	screwed BSP or NPT
TD42LA	3/8", 1/2", 3/4" and 1"	screwed BSP or NPT
TD42HA	1/2" and 3/4"	screwed BSP or NPT

Optional extras

Insulating cover: to prevent the trap being unduly influenced by excessive heat loss such as when subjected to low outside temperatures, wind, rain etc.

Integral blowdown valve: a BDV1 or BDV2 can be fitted to the strainer cap, alternatively the strainer cap can be drilled, tapped and plugged 3/8" BSP or NPT.

Pressure / temperature limits (ISO 6552)

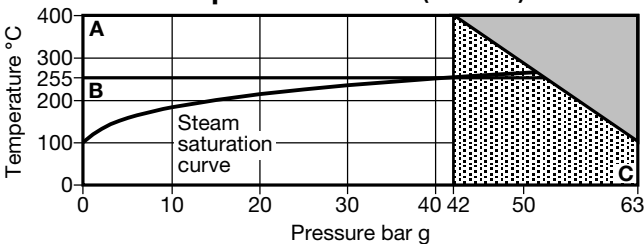

The product **must not** be used in this region.

For optimum product performance the PMO should not exceed 42 bar g.

A - C TD42L and TD42H
B - C TD42LA and TD42HA

Body design conditions	PN63
PMA Maximum allowable pressure	63 bar g @ 100°C
TMA Maximum allowable temperature	400°C @ 42 bar g
Minimum allowable temperature	0°C
PMO Maximum operating pressure	42 bar g
TMO Maximum operating temperature	TD42L and TD42H 400°C @ 42 bar g TD42LA and TD42HA 255°C @ 42 bar g
Minimum operating temperature	0°C
Minimum inlet pressure for satisfactory operation	TD42L and TD42H 0.25 bar g TD42LA and TD42HA 0.80 bar g
PMOB Maximum operating backpressure should not exceed 80% of the upstream pressure	
Designed for a maximum cold hydraulic test pressure of 95 bar g	

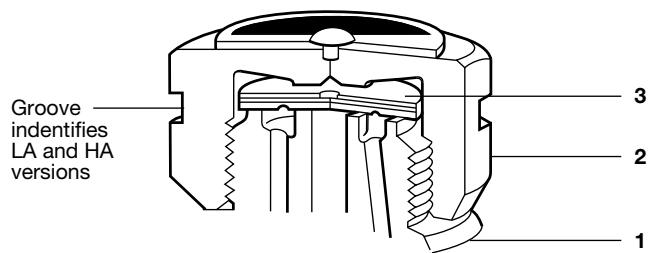
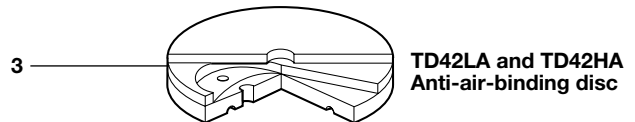
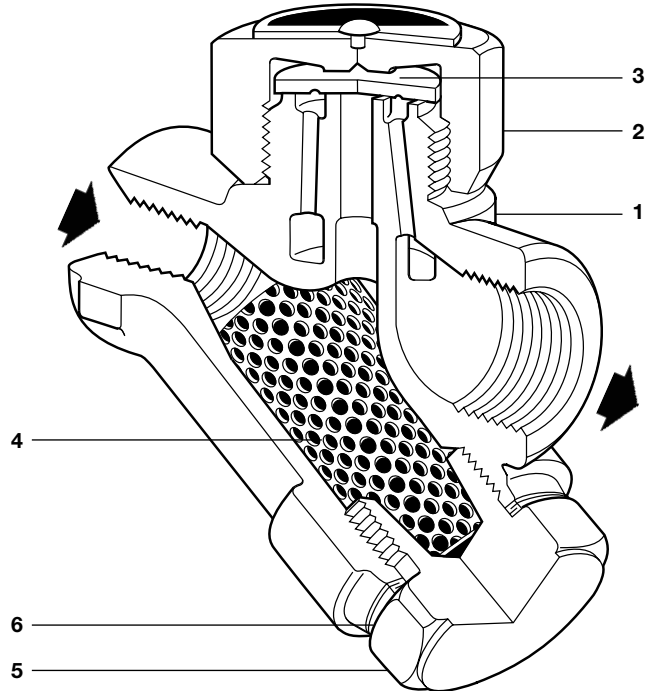

Materials

No.	Part	Material
1	Body	Stainless steel (with ENP finish) ASTM A743 Gr. CA 40 F
2	Cap	Stainless steel AISI 416
3	Disc	Stainless steel BS 1449 420 S45
4	Strainer screen	Stainless steel BS 1449 304 S16
5	Strainer cap	Stainless steel AISI 416
6	Strainer cap gasket	Stainless steel BS 1449 304 S16
7	Insulating cover (optional extra)	Aluminium

Capacities

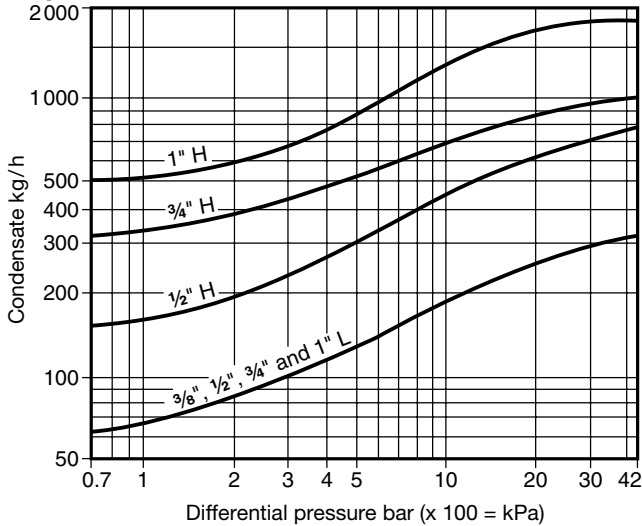

Dimensions / weights (approximate) in mm and kg

Size	A	B	E	G	H	J	K	L	Weight
3/8" L	41	78	55	85	20	52	57	38	0.80
1/2" L	41	78	55	85	20	52	57	38	0.75
3/4" L	44	85	60	100	20	52	57	38	0.95
1" L	48	95	65	100	20	58	57	38	1.50
1/2" H	41	78	55	85	41	57	57	38	0.80
3/4" H	47	90	60	100	41	63	57	38	1.00
1" H	53	96	66	100	41	-	-	-	1.50

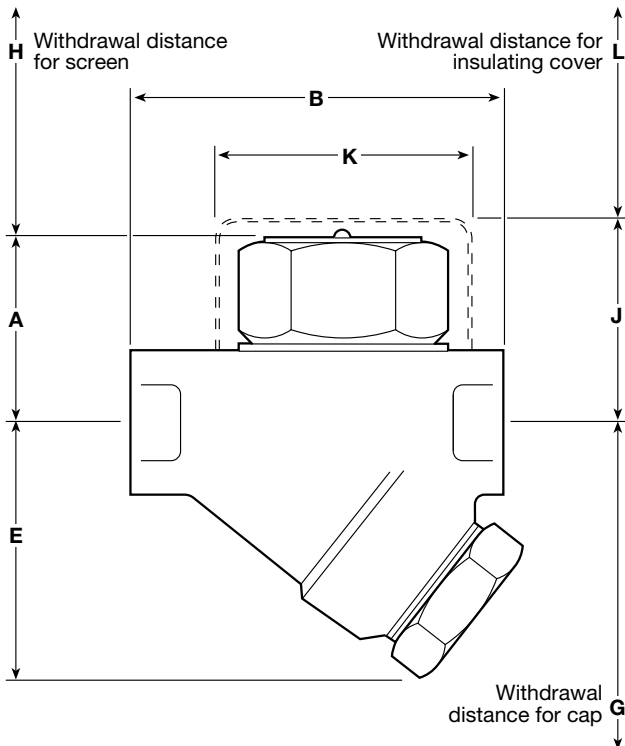

Safety information, installation and maintenance

For full details see the Installation and Maintenance Instructions (IM-P068-24) supplied with the product.

Installation note:

The TD42L and TD42H should be installed in the horizontal plane, with a small drop leg proceeding them.

Disposal:

This product is recyclable. No ecological hazard is anticipated with the disposal of this product providing due care is taken.

How to order

Example: 1 off Spirax Sarco 1/2" TD42L thermodynamic steam trap having screwed BSP connections.

Spare parts

The spare parts available are shown in solid outline. Parts drawn in broken line are not supplied as spares.

Available spares

Disc (packet of 3)	(TD42L or TD42H)	3
Disc and strainer screen	(TD42LA or TD42HA)	3, 4, 6
Strainer screen and gasket	(TD42L or TD42H)	4, 6
Insulating cover		7
Strainer cap gasket (packet of 3)		6

How to order spares

Always order spares by using the description given in the column headed 'Available spares' and state the size and type of trap.

Example: 1 - Strainer screen and gasket for a Spirax Sarco 1/2" TD42L thermodynamic steam trap.

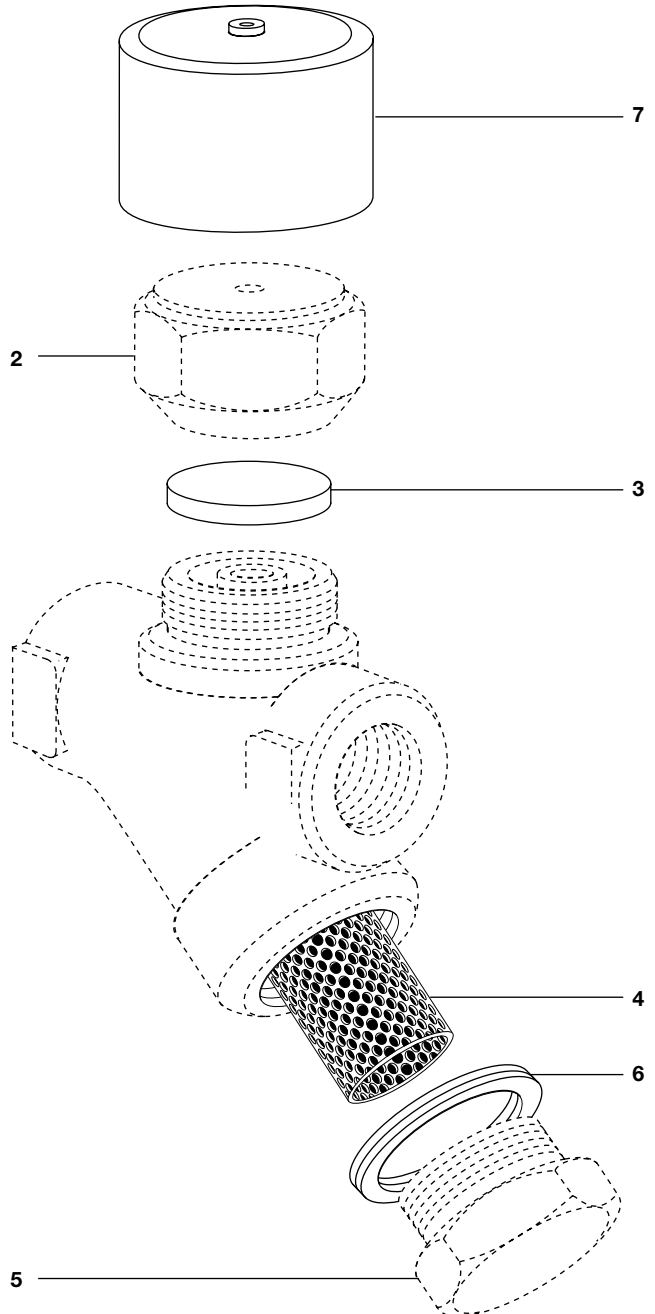

Recommended tightening torques

Item	or mm	N m
(TD42L - all sizes)	36 A/F	135 - 150
2 (TD42H - 1/2", 3/4")	41 A/F	180 - 200
(TD42H - 1")	55 A/F	250 - 275
5	32 A/F M28	170 - 190